

PRODUCT SPECIFICATION

MODEL NO	HD07VR-MH-B-1
INPUT	12VDC
DESCRIPTION	MICROWAVE HIGHBAY SENSOR
CERTIFICATE	UL (E529048)

DC POWERED BI-LEVEL DIM DUSK/DAWN MICROWAVE SENSOR CONTROL (FOR HIGHBAY LIGHT)

SHENZHEN HAISEN TECHNOLOGY CO.,LTD
13th Floor, C1 Building, Songshan Lake Intelligent Valley,
Liaobu Town, Dongguan City, 523808, Guangdong.
Contact us info@haisensz.com
www.haisensz.com

Series Work of Art
All Rights Reserved by HAISEN

WRITTEN BY	夏勇
CHECKED BY (R&D)	陈启东
CONFIRMED BY (SALES)	周慕
DATE	2022.10.20

Features & Benefits



HD07VR-MH-B-1

- Microwave sensor head, 12VDC powered, remote control.
- Bi-level dimming, daylight threshold and dusk/dawn function.
- With Audio Jack, suitable for UFO highbay application.
- With UL certificate.

Dimensions Unit:mm

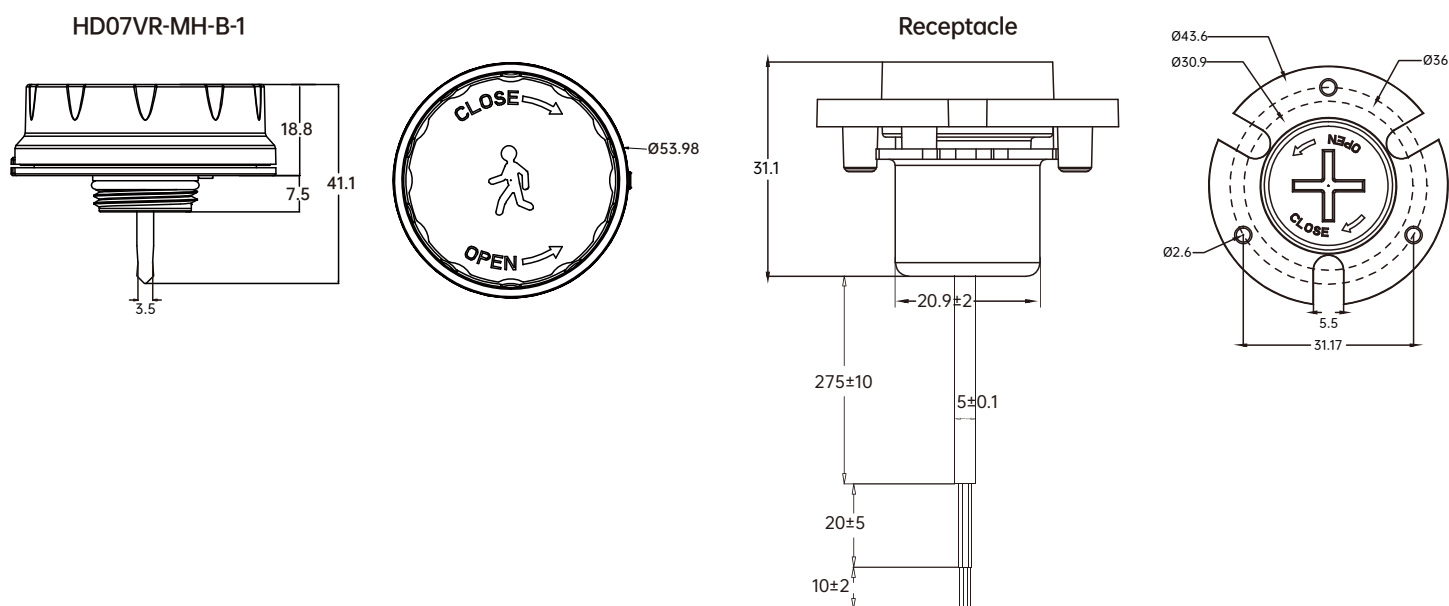

Detection Coverage

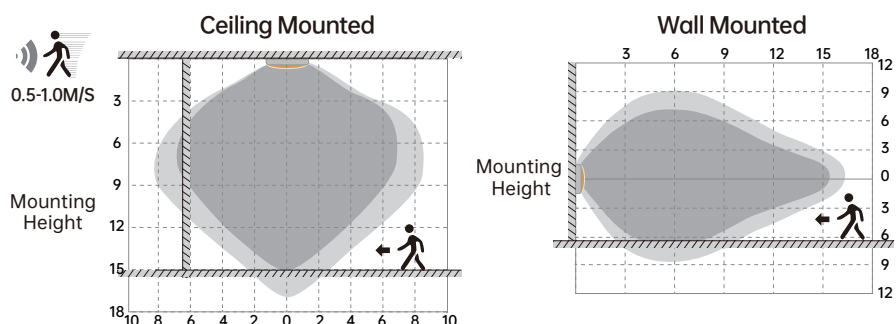

HD07VR-MH-B-1

Highest mounting height is 15m

This figure indicates the maximum distance at the highest mounting height with 100% sensitivity.

 Well Detected Area  Possibly Detected Area

Parameters

Model NO.		HD07VR-MH-B-1
MICROWAVE INFORMATION	Frequency	5.8GHz±75MHz
	Microwave Power	<0.3mW
	Installation Height	15m/49.21ft Max.
	Detection Distance	≥3m/9ft
	Warranty	5 Years
SENSOR PARAMETER	Detection Area	25%/50%/75%/100%
	Holdtime	5s/30s/1min/3min/5min/10min/20min/30min
	Daylight Threshold	Disable/ 2lux/ 10lux/ 30lux/ 50lux/ 80lux/ 120lux
	Standby Dimming Level	10%/20%/30%/50%
	Standby Period	0s/10s/30s/1min/5min/10min/30min/60min+∞
	Dusk/Dawn Sensing/ Photocell	Daylight threshold as 30lux/ 50lux/ 80lux/ 120lux Standby period as +∞ ; Standby dimming level as 10%/20%/30%
	Default Program	Detection Area - 100% Holdtime - 5S Daylight Threshold - disable Standby Period - 0S Standby Dimming Level - 10%
Control	Standard Partner HD05R, the LCD screen display remote (purchase seperately)	
INPUT	Input Range	12VDC
	Voltage Range	10-15VDC
	Current	≥30mA
OUTPUT	Signal	DIM 0-10V
	Connection	12VDC input/ Black&White wire; DIM+/ Purple wire; DIM-/ Pink wire
	Stand-by Power	<30mA Power Consumption
ENVIRONMENT	Working Temp	-20°C~+60°C
	Storage Temp	-40°C~+80°C Humidity: 85% (non-condensation)
CERTIFICATE & STANDARDS	Certification	UL (E529048)
	Environmental Requirements	In accordance with CE ROHS
	IP Rating	IP65
PACKAGE	Silk-Printing	Lasering
	Packing Description	1pcs/white neutral box
	Qty/ctn(pcs)	120
	Net Weight/pcs (kg)	0.05
	Gross Weight/CTN (kg)	11
	Carton Size (cm)	40*30*25

Wiring Diagram

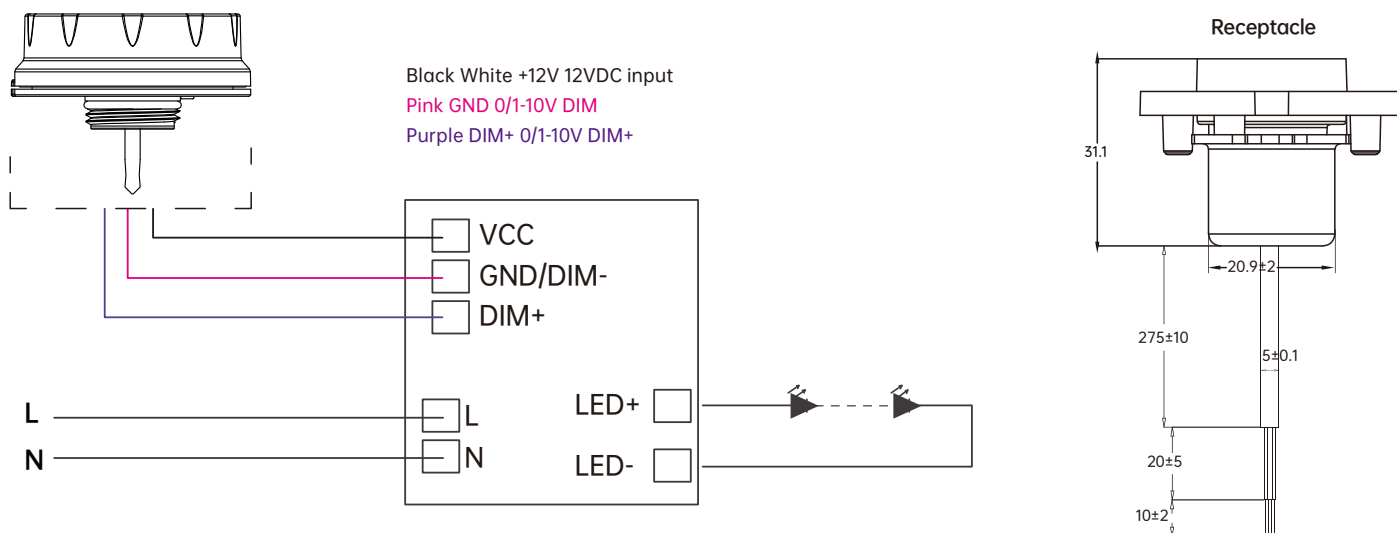

Performance

Dusk/Dawn function

HD07VR-MH-1 is able to differentiate artificial light brightness from natural light after installed inside the fixture, and automatically turn off light when ambient brightness exceeds preset lux level.

Precondition of Dusk/Dawn function:

1. Standby period is +∞;
2. Standby dimming level is on 10%, 20% or 30%;
3. Daylight threshold is on 30lux/ 50lux/ 80lux/ 120lux

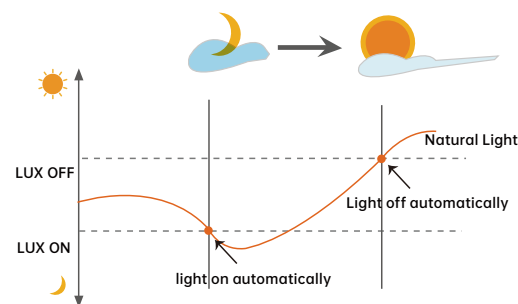

1. With Dusk/Dawn function

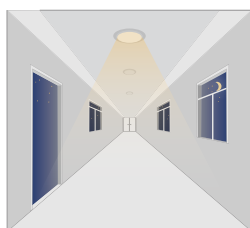

With insufficient ambient brightness, sensor turns on light and keeps it at standby dimming level even if there is no motion or presence.

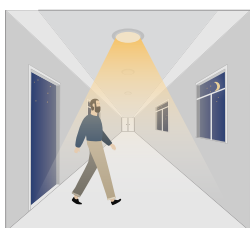

When sensor detects motion or presence it will bring the light level up to 100%.

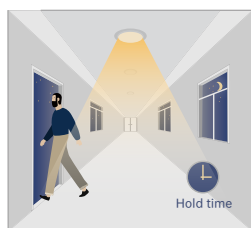

After motion is no longer detected, fixture remains at 100% for hold time.

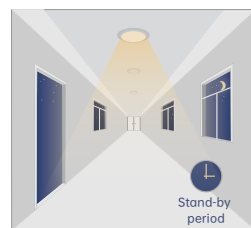

After pre-set hold time period it will dim light to standby dimming level again and always keep it.

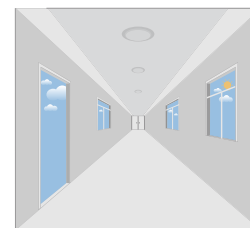

With sufficient ambient brightness, sensor will turn OFF light automatically.

2. Without daylight disabled

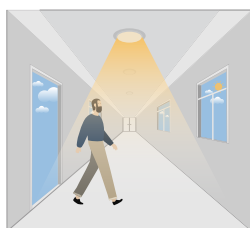

Sensor turns ON light when motion is detected.

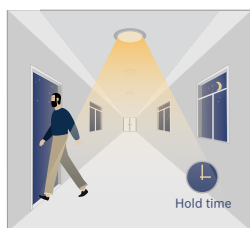

Sensor keeps for a hold time period after motion leaves

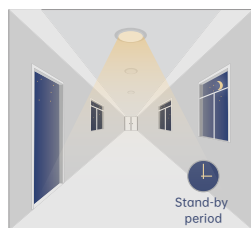

Sensor dims light to standby dimming level after hold time if there is still no motion

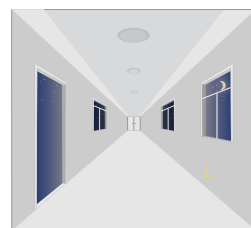

Sensor turns OFF light after standby period

3. With Daylight Threshold

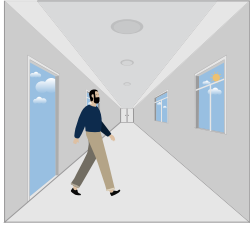

With sufficient daylight, the sensor keeps light OFF even motion gets detected

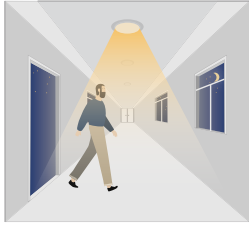

With insufficient daylight, the sensor turns light ON when motion gets detected

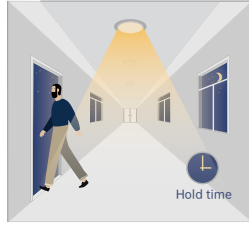

After there's no motion detected, the sensor keeps light ON 100% for holdtime.

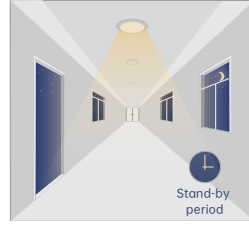

After holdtime, sensor dims light to standby dimming level for standby period. if the standby period has been set as 0s, sensor turns light OFF automatically after holdtime.

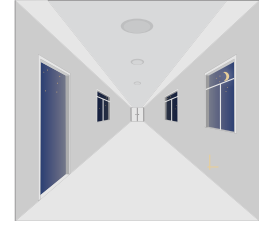

The sensor turns OFF light automatically after the standby period when there's no motion detected.



Attention

1. The sensor should be installed by qualified electrician and ensure power is OFF before installation.
2. Please read the instruction carefully before using the product and keep it well for other users to read any time.
3. We reserve the right to modify any incorrect text, image and technical parameters.
4. Any unauthorized modification is forbidden. Otherwise all guarantees will be immediately invalid.
5. Product could be optimized without prior notice.

APPLICATION NOTES

1. Suitable for indoor application, half/completely outdoor environment conditions might be captured as moving signals to trigger the sensor.
2. Suitable for ceiling mount installation, adjust sensitivity properly if it's installed on side-wall because it gets more sensitive.
3. Adjust sensitivity properly when the sensor is applied in small/narrow/metal-built/with metal spaces.
4. Microwave sensor can't be placed under/inside metal shell; Microwave module must directly face the detection area with edge lower than light fixture.
5. Keep the sensor away from vibration equipments, air-conditioning outlets, smoke extractors alike conditions to avoid unwanted trigger.
6. Keep the sensor module away from AC input and DC output to avoid high/low frequency signal interference.
7. At least 2m/6.5ft distance between microwave sensors; 1.5m/4.9ft between the sensor and other wireless devices such as routers to avoid possible radio interference.
8. Daylight testing delivered in bright day without shadow or specially designed lampshade or lens.
9. Dimming performance differs when connected to different drivers; If the driver can't completely turn OFF, sensor can't either.
10. Input power voltage must be stable with float less than 10%.
11. The first time powered ON sensor, light will be ON 100% for about 10S then dims to standby level or OFF.
12. Distance detection is delivered by testing person about 165cm in open area as reference, the result differs by size and speed of moving objects, mounting height and real-life situation.